

CZ6354

ATEX, IECEx certified 2MP 32X Starlight Network Explosion

Proof PTZ Speed Dome Camera



Changzhou Zuoan Electronics Co., Ltd.
Peace village, Zhenglu Town, Tianning District, Changzhou, Jiangsu, P.R. China
Web: en.zaex.com.cn zuosan818@zaex.com.cn
Tel: 0519-88962115-873 Fax: 0519-88968180



Features

- ATEX, IECEx certified
- Application: gas zone 1, zone 2; dust zone 21, 22.
- Exd II CT6 Gb/ Ex tD A21 IP68 T80°C
- Stainless steel 304 or 316L
- Optional electropolished or corrosion resistant paint finish
- Enclosure Protection: IP66, IP68(2m/2h)
- Wide voltage input: AC100-240V or AC24V or DC24V or PoE++
- Powerful optical zoom and accurate pan/tilt zoom performance
- 1/2.8" 2Megapixel STARVIS™ CMOS
- Max. 50/60 fps@1080P
- All-in-one solution for capturing long distance video surveillance for outdoor applications
- Start-light technology fits for dark, low-light applications
- True WDR for applications with direct sunlight or glare.
- Automatically filters out false alarms caused by animals, rustling leaves, bright lights, etc
- Automatically track an object in motion and keep it in the scene.
- Smart H.265+ technology reduces bit rate and storage requirements by up to 70% when compared to standard H.265 video compression.
- Wall and ceiling mounted way
- Optical fiber output version available

Application

CZ6354 series is a ZUOAN designed classic explosion-proof speed dome camera, which is integrated by explosion proof enclosure, speed dome module, sunshield. The explosion proof speed dome camera is applicable to Zone 1 and Zone 2 hazardous areas that explosive mixture of group IIA, IIB, IIC, T1~T6 gases, vapors and air may exist, Zone 21 and Zone 22 hazardous areas that explosive dust may exist, e.g. refining and chemical industry, oil extraction, gas production, fireworks production, grain production and storage, petrol station and so on.

CZ6354-□□□ EXPLOSION PROOF FIXED CAMERA

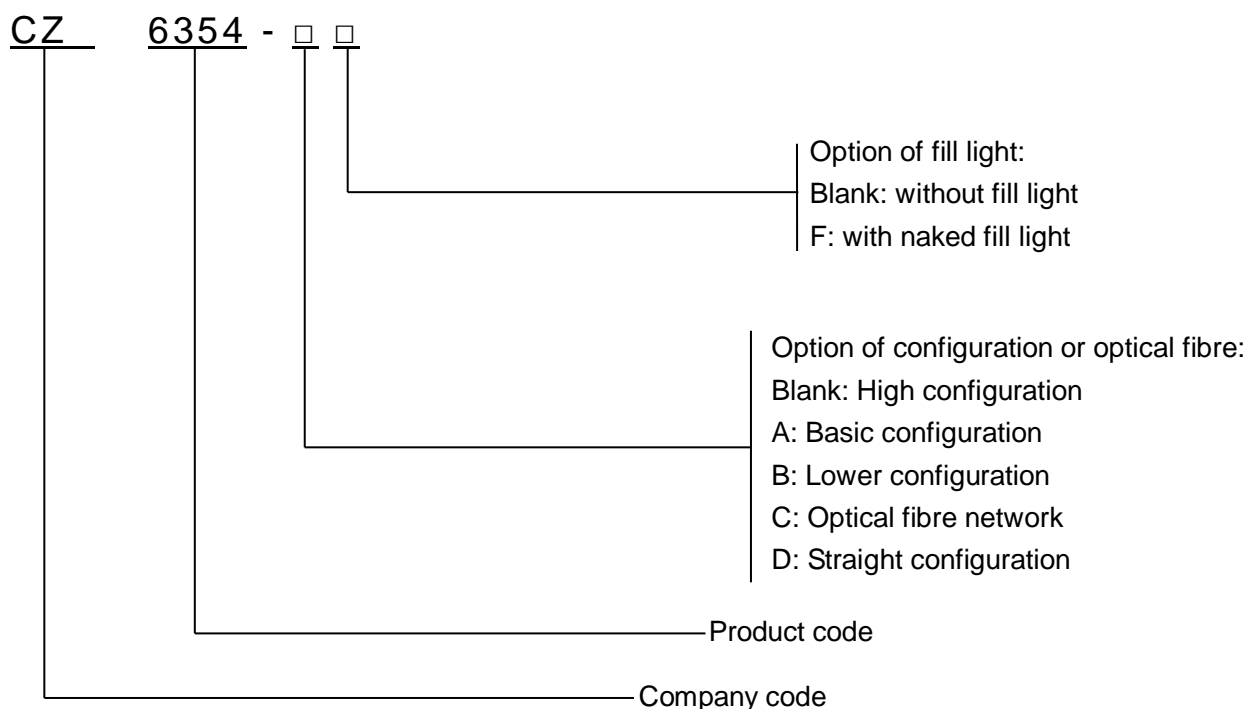

Specification:

Camera	
Image Sensor	1/2.8" STARVIS™ CMOS
Pixel	2MP
Max. Resolution	1920 (H) x 1080 (V)
ROM	4 GB
RAM	1 GB
Electronic Shutter Speed	1/1 s–1/30000 s
Scanning System	Progressive
Min. Illumination	Color: 0.005 Lux@F1.35 B/W: 0.0005 Lux@F1.35
Lens	
Focal Length	4.9 mm–156 mm
Max. Aperture	F1.35–F4.4
Field of View	H: 62.8°–2.2°; V: 36.7°–1.3°; D: 69.2°–2.6°
Optical Zoom	32x
Focus Control	Auto/Semi-Auto/Manual

Changzhou Zu'an Electronics Co., Ltd.
Peace village, Zhenglu Town, Tianning District, Changzhou, Jiangsu, P.R. China
Web: en.zaex.com.cn zuan818@zaex.com.cn
Tel: 0519-88962115-873 Fax: 0519-88968180



Close Focus Distance	1 m–1.5 m (3.28 ft–4.92 ft)			
Iris Control	Auto/Manual/Fixed			
DORI Distance	Detect	Observe	Recognize	Identify
	2152 m (7060.37 ft)	850 m (2788.71 ft)	430 m (1410.76 ft)	215 m (705.38 ft)

PTZ

Pan/Tilt Range	Pan: 0°–360° endless Tilt: 0° to +90°, auto flip 180
Manual Control Speed	Pan: 0.1°/s–350°/s Tilt: 0.1°/s–250°/s
Preset Speed	Pan: 500°/s Tilt: 500°/s
Presets	300
Tour	8 (up to 32 presets per tour)
Pattern	5
Scan	5
Power-off Memory	Support
Idle Motion	Preset/Tour/Pattern/Scanning
Protocol	DH-SD Pelco-P/D (auto recognition)

General Intelligence

Event Trigger	Motion detection, video tampering, scene changing, Network disconnection, IP address conflict, illegal access, and storage anomaly.
IVS	Object Abandoned/Missing

Artificial Intelligence

Smart Capture	Support human, motor vehicle and non-motor vehicle image capture.
Perimeter Protection	Tripwire and intrusion. Support alarm triggering by target types (human and vehicle). Support filtering false alarms caused by animals, rustling leaves, bright lights, etc.
Face Detection	Support
Auto Tracking	Support
SMD PLUS	Support





Video

Compression	H.265; H.264B; H.264M; H.264H; MJPEG (Sub Stream); H.265+; H.264+
Streaming Capability	3 streams
Resolution	1080P (1920 × 1080); 1.3M (1280 × 960); 720P (1280 × 720); D1 (704 × 576); CIF (352×288)
Frame Rate	Main stream: 1080P/1.3M/720P (1–50/60 fps)

	Sub stream 1: D1/CIF (1–25/30 fps) Sub stream 2: 720P (1–25/30 fps)
Bit Rate Control	Variable/Constant
Bit Rate	H.264: 3 Kbps–20480 Kbps H.265: 3 Kbps–20480 Kbps
Day/Night	Auto (ICR)/Color/B/W
BLC	Support
WDR	120 dB
HLC	Support
White Balance	Auto/Indoor/Outdoor/Tracking/Manual/Sodium lamp/ Natural light/Street lamp
Gain Control	Auto/Manual
Noise Reduction	2D/3D
Motion Detection	Support
Region of Interest (RoI)	Support
Image Stabilization	Electronic
Defog	Electronic
Digital Zoom	16x
Flip	180°
Privacy Masking	Up to 24 areas, and up to 8 areas in the same view
S/N Ratio	≥ 55 dB
Optional Audio	
Compression	G.711a; G.711Mu; G.726; AAC; MPEG2-Layer2; G722.1; G729; G723
Network	
Ethernet	RJ-45 (10/100Base-T)
Protocol	IPv4; IPv6; HTTP; HTTPS; 802.1x; Qos; FTP; SMTP; UPnP; SNMPv1/v2c/v3 (MIB-2); DNS; DDNS; NTP; RTSP; RTP; TCP; UDP; IGMP; ICMP; DHCP; PPPoE; ARP; RTCP
Interoperability	ONVIF Profile S&G&T; CGI
Streaming Method	Unicast/Multicast
User/Host	20 (total bandwidth 64M)
Storage	FTP; Micro SD card (256G); NAS
Browser	IE7 and later versions Chrome 42 and earlier versions Firefox 52 and earlier versions Safari
Management Software	Smart PSS; DSS; DMSS; Easy4ip; IVSS
Mobile Phone	IOS, Android

Changzhou Zuoa Electronics Co., Ltd.
Peace village, Zhenglu Town, Tianning District, Changzhou, Jiangsu, P.R. China
Web: en.zaex.com.cn zuoan818@zaex.com.cn
Tel: 0519-88962115-873 Fax: 0519-88968180



Certification	
Certifications	ATEX, IECEx certified
Explosion proof certification	DNV 21 ATEX 38340X IECEX DNV 21.0048X
ATEX Explosion proof marking	With optical fiber:  II 2 G Ex db op pr II C T6 Gb  II 2 D Ex tb op pr IIIC T80 °C Db Without optical fiber:  II 2 G Ex db II C T6 Gb  II 2 D Ex tb IIIC T80 °C Db
IECEX Explosion proof marking	Without optical fibre: Ex db IIC T6 Gb Ex tb IIIC T80°C Db With optical fibre: Ex db op pr IIC T6 Gb Ex tb op pr IIIC T80°C Db
Optional Port	
Audio Input	1
Audio Output	1 (LINE OUT; bare wire)
Two-way Audio	Support
Alarm I/O	2/1
Power	
Power Supply	DC24V/2.5A PoE+ (802.3at)
Power Consumption	Basic:10W Max:16W
Environment	
Operating Temperature	-40°C to +60°C (-40°F to +140°F)
Operating Humidity	≤ 95%
Air pressure	80~110kPa
General	
Dimensions	245*245*302mm (without bracket)
Weight	13.5kg (without bracket)
Cable	Integrated cable
Cable thread hole	1pcs M27×1.25 or M25×1.5
Housing	Stainless steel 304 or 316L
IP	IP66, IP68 (2m/2h)
Sunshade	Support

Changzhou Zuoan Electronics Co., Ltd.
Peace village, Zhenglu Town, Tianning District, Changzhou, Jiangsu, P.R. China
Web: en.zaex.com.cn zuoan818@zaex.com.cn
Tel: 0519-88962115-873 Fax: 0519-88968180



Wall bracket	ZAZ637-B
Ceiling bracket	ZAZ637-D

Dimension (With Wall Bracket)

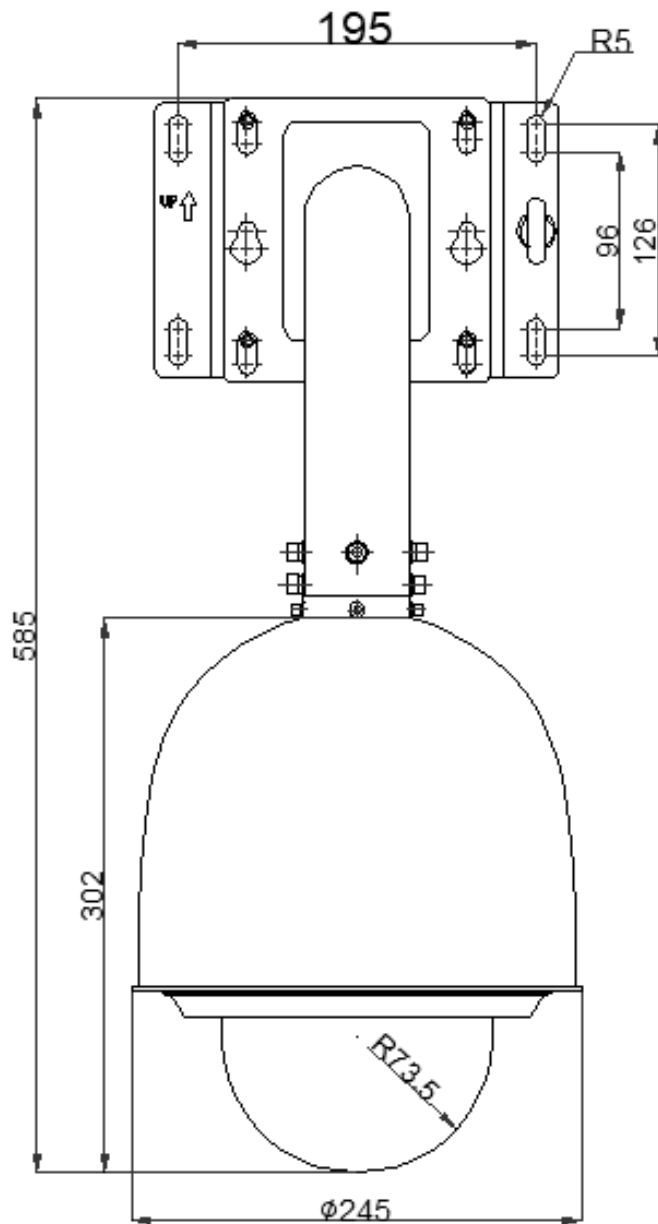

ZAZ637-B wall bracket



ZAZ637-D ceiling mounted bracket

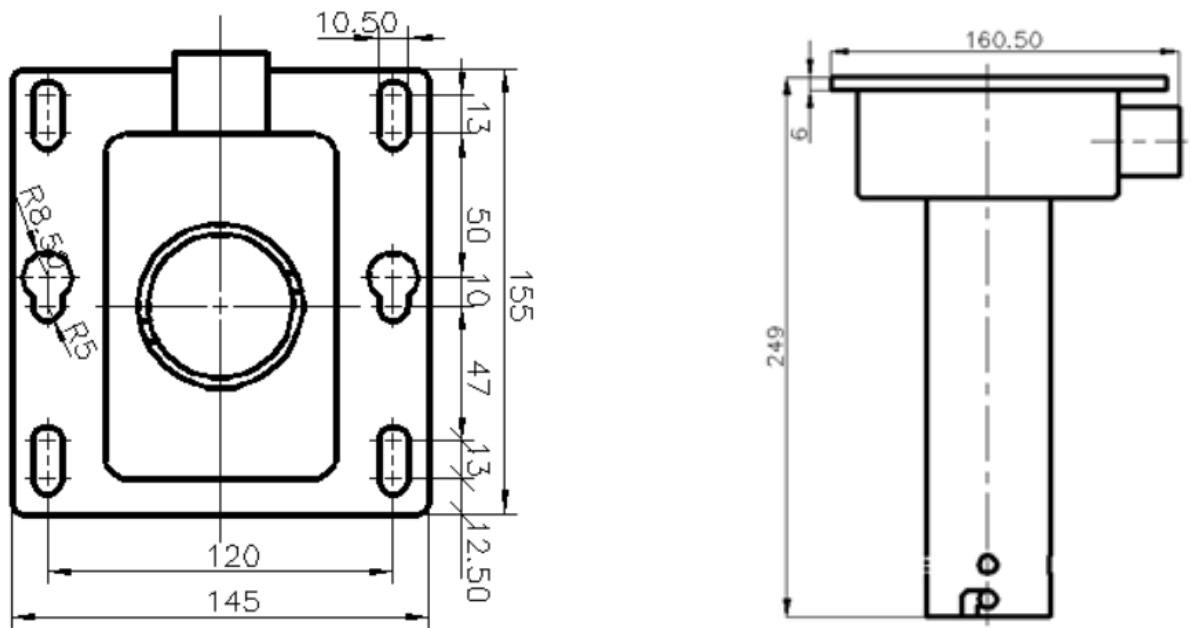

Ceiling mount bracket dimension